

vtech[®]

Instruction Manual

Go!Go! Smart Wheels[®]

Spiral Construction Tower™



INTRODUCTION

Little ones will love exploring the **VTech® Go! Go! Smart Wheels® Spiral Construction Tower™**. Load, transport and unload the materials with the dump truck, crane tower and excavator. It's time to get hauling!

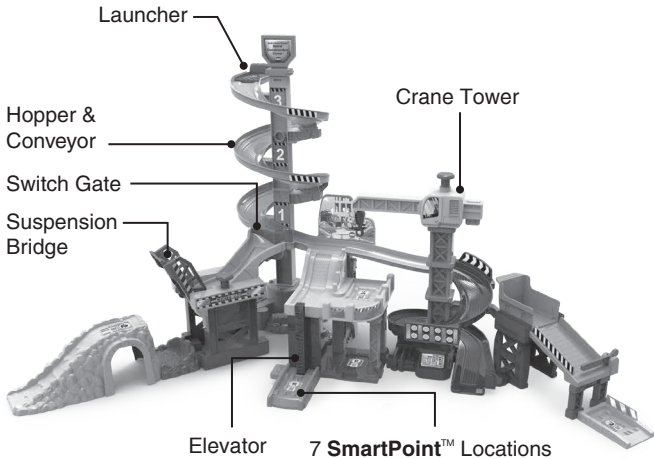

SmartPoint™
Dump Truck



Excavator



Mixer



3 Accessories

INCLUDED IN THE PACKAGE



One **SmartPoint™**
Dump Truck



One
excavator



One mixer



One rock



Six tracks (A,B,C,D,E,F)



One sign



Two spiral track
supports



Two tower
supports

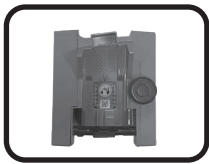

One **SmartPoint™**
bridge



One track switcher

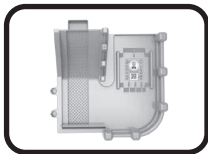

One **SmartPoint™**
platform



One ground floor
base



Two bridge supports



One mud track



One small track



One **SmartPoint™** mountain

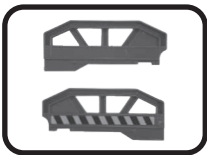

Two bridge rails



One bridge floor



One elevator support



One elevator cover



Two small elevator supports

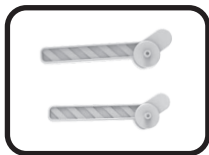

Two exit gate



One elevator wall



One **SmartPoint™** lift



One conveyor support



One **SmartPoint™** loading location



One hanging sign plate

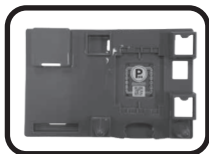

One **SmartPoint™** parking base



One rectangle plate

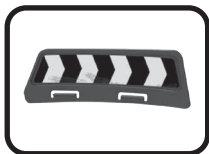

One arc-shaped plate



One conveyor bracket



One tower base

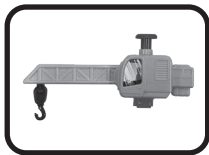

one crane

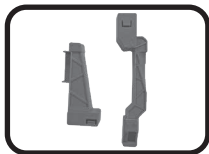

Two tower brackets



One L-shaped plate



One conveyor belt



One mini support



One wood



One steel

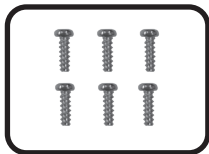

Six screws

- Sticker Sheet
- Quick Start Guide

WARNING

All packing materials such as tape, plastic sheets, packaging locks, removable tags, cable ties, cords and packaging screws are not part of this toy, and should be discarded for your child's safety.

NOTE

Please save this manual as it contains important information.

ATTENTION

Pour la sécurité de votre enfant, débarrassez-vous de tous les produits d'emballage tels que rubans adhésifs, feuilles de plastique, attaches, étiquettes, cordons et vis d'emballage. Ils ne font pas partie du jouet.

NOTE

Il est conseillé de sauvegarder ce manuel car il comporte des informations importantes.

CAUTION

This package contains small screws. Adult assembly required.

For your child's safety, do not let your child play with the toy until it is fully assembled.

If there are no locks inside the package, disregard this message.

Removing the Packaging Locks:

- ① Turn the packaging locks anticlockwise several times.
- ② Pull out the packaging locks and discard.

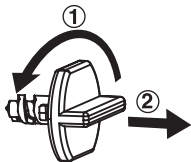

CAUTION:

This package contains small screws. Adult assembly required.
For your child's safety, do not let your child play with the toy until it is fully assembled.



ATTENTION!

Ce jouet contient des petites vis. Ce jouet doit être assemblé par un adulte. Pour la sécurité de votre enfant, ne pas le laisser jouer avec le jouet tant que ce dernier n'est pas complètement assemblé par un adulte.

INSTRUCTIONS

Battery Removal And Installation -- Dump Truck

1. Make sure the unit is turned **OFF**.
2. Find the battery cover located on the bottom of the Dump Truck, use a screwdriver to loosen the screw and then open the battery cover.
3. Remove old batteries by pulling up on one end of each battery.
4. Install 2 new AAA (AM-4/LR03) batteries following the diagram inside the battery box. (For best performance, alkaline batteries or fully charged Ni-MH rechargeable batteries are recommended).
5. Replace the battery cover and tighten the screw to secure.

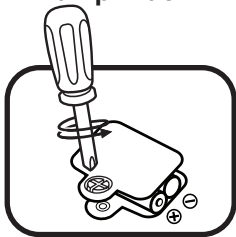

WARNING:

Adult assembly required for battery installation.
Keep batteries out of reach of children.



ATTENTION :

Les piles ou accumulateurs doivent être installés par un adulte.
Tenir les piles ou accumulateurs hors de portée des enfants.

IMPORTANT: BATTERY INFORMATION

- Insert batteries with the correct polarity (+ and -).
- Do not mix old and new batteries.
- Do not mix alkaline, standard (carbon-zinc) or rechargeable batteries.
- Only batteries of the same or equivalent type as recommended are to be used.

- Do not short-circuit the supply terminals.
- Remove batteries during long periods of non-use.
- Remove exhausted batteries from the toy.
- Dispose of batteries safely. Do not dispose of batteries in fire.

RECHARGEABLE BATTERIES

- Remove rechargeable batteries (if removable) from the toy before charging.
- Rechargeable batteries are only to be charged under adult supervision.
- Do not charge non-rechargeable batteries.

IMPORTANT : INFORMATIONS CONCERNANT LES PILES

- Mettre en place les piles ou les accumulateurs en respectant les polarités + et –.
- Ne pas mélanger des piles ou des accumulateurs neufs avec des usagés.
- Ne pas mélanger différents types de piles : alcalines, zinc-carbone et rechargeables.
- Seules des piles du type recommandé doivent être utilisées.
- Ne pas mettre les bornes d'une pile ou d'un accumulateur en court-circuit (en reliant directement le + et le –).
- Retirer les piles ou les accumulateurs en cas de non-utilisation prolongée.
- Enlever les piles ou les accumulateurs usagés du jouet.
- Ne les jeter ni au feu ni dans la nature.

PILES RECHARGEABLES

- Enlever, lorsque c'est possible, les accumulateurs du jouet pour les recharger.
- Les accumulateurs ne doivent être chargés que sous la surveillance d'un adulte.
- Ne pas tenter de recharger des piles non rechargeables.

LABEL APPLICATION

Please adhere the labels to the playset securely as indicated on the following page:

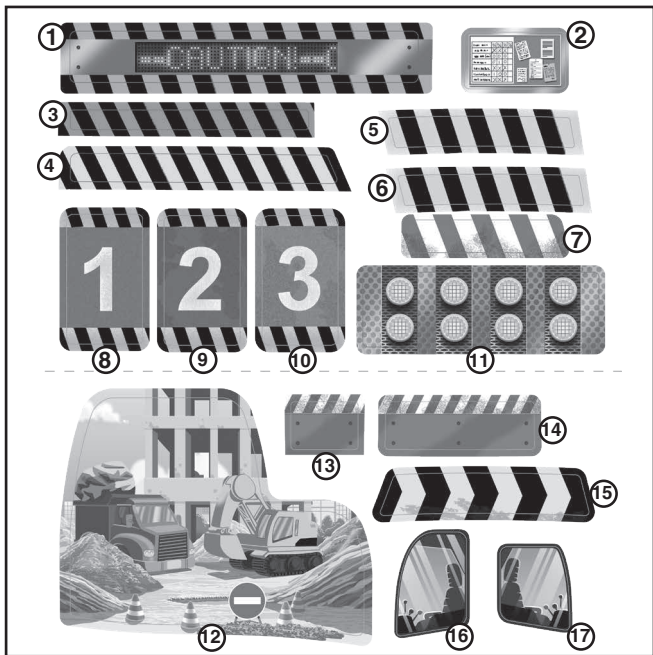

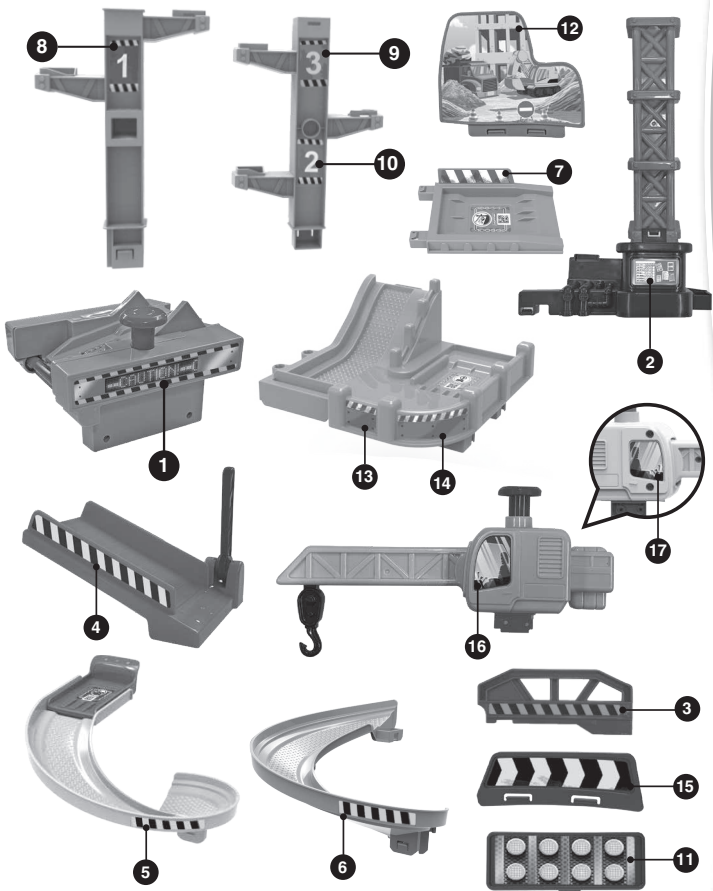

ASSEMBLY INSTRUCTIONS

With the **Go! Go! Smart Spiral Construction Tower™**, safety comes first. To ensure your child's safety, adult assembly is required.

1. Assemble the 3-loop spiral track components following the steps below:

A: Insert one Spiral Support into the Spiral Track Base, then attach the other Spiral Support. Make sure you hear a clicking sound to confirm they are firmly connected. Tighten it with two screws to secure.

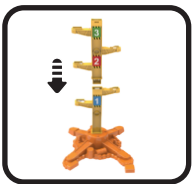
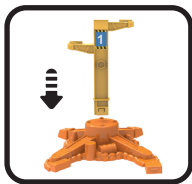

B: Attach Track A to the Spiral Support; attach Track B to Track A, attach Track C to Track B; attach the Sign to the Tower Support.

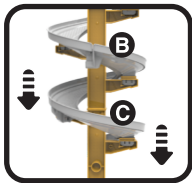
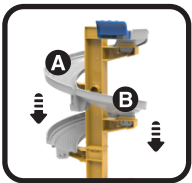
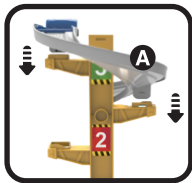



2. Assemble the bridge components following the steps below:

A. Attach two Bridge Supports to the Bridge Base. Connect two Bridge Supports to the Mud Track. Attach the Small Track to the Bridge Base.

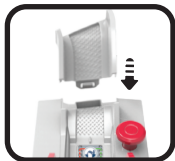
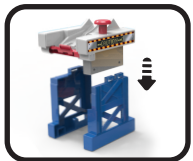

B. Attach two Bridge Rails to the Bridge Floor, insert the Bridge Floor into the SmartPoint® Bridge.

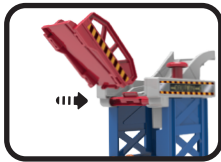
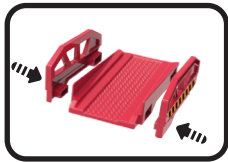

C. Connect the SmartPoint® Mountain to the Mud Track.



3. Assemble the elevator components following the steps below.

A. Insert two small Elevator Supports, the Elevator Wall and the Elevator Support into the SmartPoint® Parking Base.

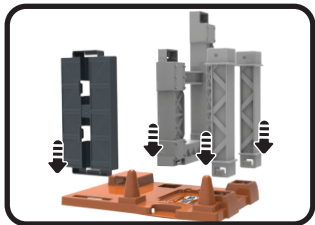

B. Attach the SmartPoint® Platform to the three Elevator Supports and the Elevator Wall.

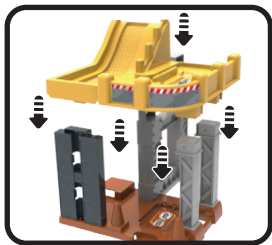

C. Insert the Elevator Cover to the Elevator Wall, then connect the SmartPoint® Elevator to the Elevator Cover.

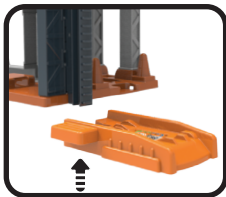
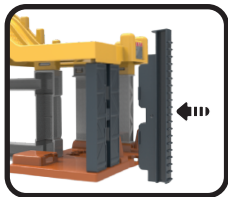



4. Assemble the crane and track components following the steps below:

A. Insert the Tower Support into the Crane. Secure it with two screws. Tighten the Tower Support into the Tower Base with two screws to secure.

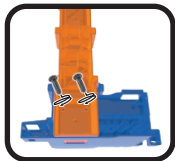
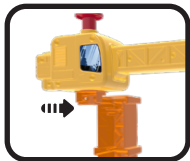

B. Insert two Tower Brackets into the Tower Support.

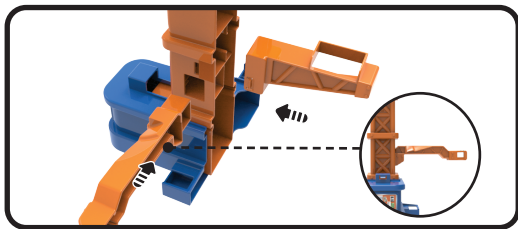

C. Connect Track E to the Tower Base. Connect Track D to Track E and the Tower Base. Connect Track D to the Tower Support.

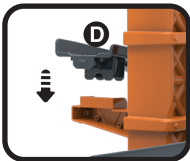
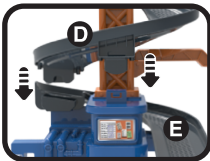
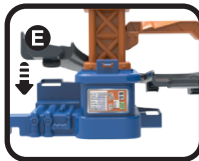

D. Insert two Plates into Track D, the Exit Gate into Track E, and the Mini Support into Track E.

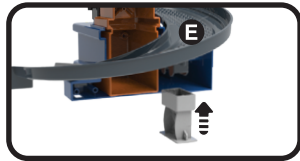
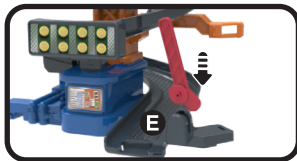
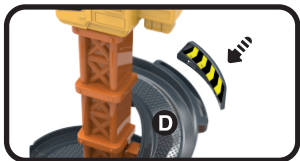
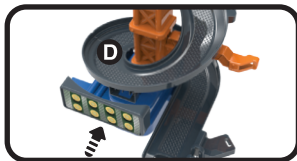

5. Assemble the Hopper and conveyor components following the steps as below:

A. Insert two Supports into the Conveyor Bracket, attach the Hopper to the Conveyor Bracket, insert the Conveyor Belt into the Hopper.

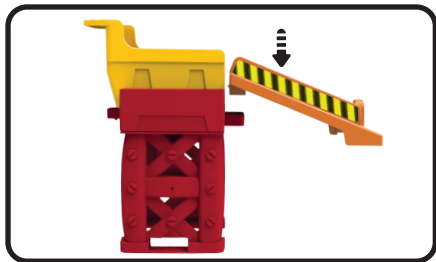
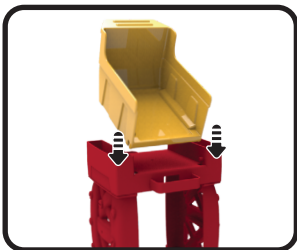
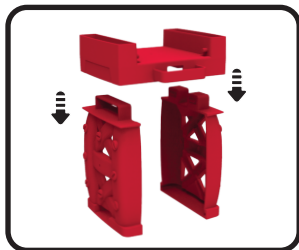

B. Insert the Conveyor Support into the Conveyor Belt, the SmartPoint® Loading Location into the Conveyor Support, and the Exit Gate into Conveyor Belt.

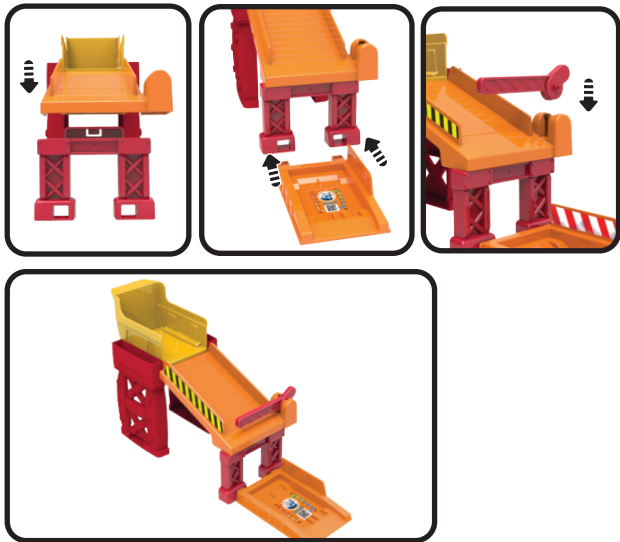

6. Assemble and attach the construction tower components following the steps as below:

A. Insert the Switch Gate into Track F. Connect Track F to the 3-loop spiral tower, connect the bridge part to Track F, insert the Spiral Track Base into the Bridge Support, and insert the L-shape Plate Plates into Track F.

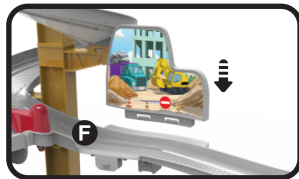
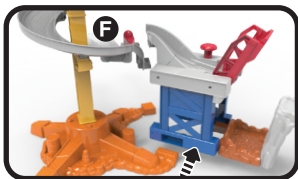
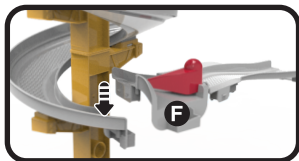
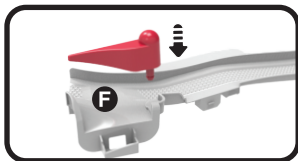

B. Insert the SmartPoint® Parking Base into the Spiral Track Base. Attach the SmartPoint® Platform to Track F.

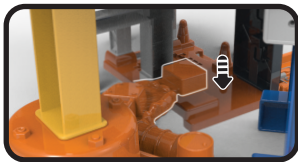

C. Attach the Tower Base to the SmartPoint® Parking Base. Connect Track F and Track D.

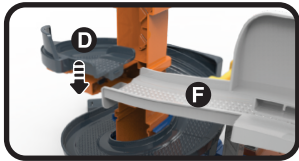
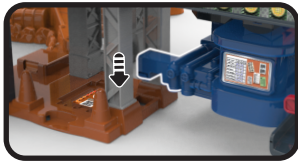

D. Insert the Conveyor Bracket into the Tower Bracket, and insert Track E into the Conveyor Support.

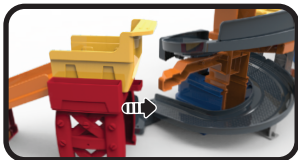



Once you've completed the above steps, you are ready to play! You can also connect the construction tower to other **Go! Go! Smart Wheels®** track sets (each sold separately).



PRODUCT FEATURES

1. On/Off Switch

To turn the unit **On**, slide the **On/Off Switch** to the **On** () position. To turn the unit **Off**, slide the **On/Off Switch** to the **Off** () position.

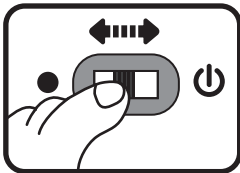

2. Automatic Shut-Off

To preserve battery life, the **Go! Go! Smart Wheels® Dump Truck** will automatically power down after approximately 60 seconds without input. The unit can be turned on again by pressing the light up button, rolling the Fire Truck quickly or triggering a SmartPoint® location.

Note: This product is in Try-Me mode in the packaging. After opening the package, turn the Dump Truck off and on again to proceed with normal play. If the unit powers down while playing, we suggest changing the batteries.

ACTIVITIES

Dump Truck

1. Press the **Light-up Button** to hear fun phrases, songs, sounds and melodies. While a melody is playing, continue pushing the **Dump Truck** to add fun sounds on top of the melody. The windshield light will flash with sounds.
2. Push the **Dump Truck** to hear fun sounds and phrases. The windshield light will flash with sounds.



3. Raise and lower the **Truck Bed** to hear fun sounds and phrases. The windshield light will flash with sounds.
4. Place the **Dump Truck** on one of the playset's seven **SmartPoint**[®] locations to see the **Dump Truck's** lights flash and to hear fun sounds, short tunes and phrases. The **Dump Truck** even interacts with other **Go! Go! Smart Wheels**[®] playsets (other playsets sold separately).

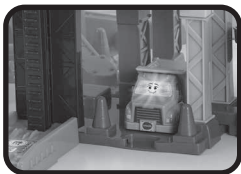

ACTIVITIES

Construction Tower

1. Place the **Dump Truck** or any **SmartPoint**[®] vehicle (each sold separately) on any of the seven **SmartPoint**[®] locations to trigger fun sounds, songs or phrases.
2. Put materials in the Truck Bed to load and transport.



3. Put the **Dump Truck** on the SmartPoint® Launcher, then lift the launcher to get the **Dump Truck** sliding.



4. Rotate the Switch Gate to let the **Dump Truck** to the long ramp or the Bridge.

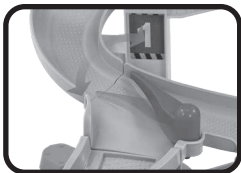

5. Press the Bridge Button to lower the Bridge to make the **Dump Truck** go through.

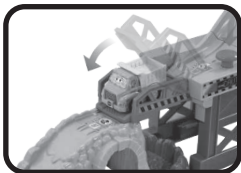

6. Put the **Dump Truck** on the SmartPoint® Mountain and unload materials.



- 7 Put the **Dump Truck** on the SmartPoint® Elevator and then move the elevator up and down.



8. Put the **Dump Truck** on the SmartPoint® Parking Base to have a rest.

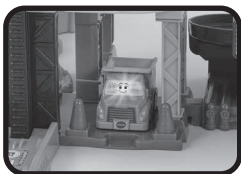

9. Load metal beams or logs into the **Dump Truck** and place it on the SmartPoint® Platform. Press the big button to hook the materials with the crane's hook, spin the crane and press the button to unload the materials into the Hopper.

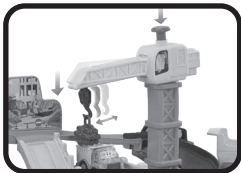

10. Flip the Hopper to dump the materials.



11. Put the **Dump Truck** on the SmartPoint® Loading Location to load materials.



MELODY LIST

1. Teddy Bear's Picnic
2. The Bear Went Over the Mountain
3. Sailing, Sailing
4. Man on the Flying Trapeze
5. Hey, Diddle Diddle
6. On Top of Old Smokey

SONG

Song 1

Load the rocks and hit the road,
To and fro and then unload

Song 2

I'm haulin' and dumpin' all a-day long,
Putting all the piles right where they belong

Song 3

Go! Go! Smart Wheels!
I'm a Go! Go! Smart Wheels! Dump Truck
Haulin' everywhere (Go! Go!)
Fill me up and dump me out,
Let's Go! Go! and see (Go! Go!)

Song 4

I can clean and tidy,
I can fix a mess.
Load it all in my truck bed,
Then dump it! That's the best.

CARE & MAINTENANCE

1. Keep the unit clean by wiping it with a slightly damp cloth.
2. Keep the unit out of direct sunlight and away from any direct heat sources.
3. Remove the batteries if the unit will not be in use for an extended period of time.
4. Do not drop the unit on a hard surface and do not expose the unit to moisture or water.

TROUBLESHOOTING

If for some reason the unit stops working or malfunctions, please follow these steps:

1. Turn the unit **Off**.
2. Interrupt the power supply by removing the batteries.
3. Let the unit stand for a few minutes, then replace the batteries.
4. Turn the unit **On**. The unit should now be ready to play again.
5. If the unit still does not work, install a new set of batteries.

IMPORTANT NOTE:

If the problem persists, please call our **Consumer Services Department** at **1-800-521-2010** in the U.S. or **1-877-352-8697** in Canada, or by going to our website at **vtechkids.com** and filling out our **Contact Us** form located under the **Customer Support** link. Creating and developing VTech products is accompanied by a responsibility that we take very seriously. We make every effort to ensure the accuracy of the information, which forms the value of our products. However, errors sometimes can occur. It is important for you to know that we stand behind our products and encourage you to contact us with any problems and/or suggestions you might have. A service representative will be happy to help you.

CAUTION

Changes or modifications not expressly approved by the party responsible for compliance could void the user's authority to operate the equipment.

NOTE

This equipment has been tested and found to comply with the limits for a Class B digital device, pursuant to Part 15 of the FCC Rules. These limits are designed to provide reasonable protection against harmful interference in a residential installation. This equipment generates, uses and can radiate radio frequency energy and, if not installed and used in accordance with the instructions, may cause harmful interference to radio communications. However, there is no guarantee that interference will not occur in a particular installation. If this equipment does cause harmful interference to radio or television reception, which can be determined by turning the equipment off and on, the user is encouraged to try to correct the interference by one or more of the following measures:

- Reorient or relocate the receiving antenna
- Increase the separation between the equipment and receiver
- Connect the equipment into an outlet on a circuit different from that to which the receiver is connected
- Consult the dealer or an experienced radio/TV technician for help

Supplier's Declaration of Conformity

47 CFR § 2.1077 Compliance Information

Trade Name: VTech®
Model: 5433
Product Name: Spiral Construction Tower™
Responsible Party: VTech Electronics North America, L.L.C
Address: 1156 W. Shure Drive, Suite 200
Arlington Heights, IL 60004
Website: vtechkids.com

THIS DEVICE COMPLIES WITH PART 15 OF THE FCC RULES.
OPERATION IS SUBJECT TO THE FOLLOWING TWO CONDITIONS:
(1) THIS DEVICE MAY NOT CAUSE HARMFUL INTERFERENCE, AND
(2) THIS DEVICE MUST ACCEPT ANY INTERFERENCE RECEIVED,
INCLUDING INTERFERENCE THAT MAY CAUSE UNDESIRE
OPERATION.

CAN ICES-003(B)/NMB-003(B)

**Visit our website for more
information about our products,
downloads, resources and more.**

vtechkids.com
vtechkids.ca

Read our complete warranty policy online at
vtechkids.com/warranty
vtechkids.ca/warranty

